



**New Features Summary**

---

**PowerDesigner® 16.5**

Windows

DOCUMENT ID: DC10077-01-1650-01

LAST REVISED: January 2013

Copyright © 2013 by Sybase, Inc. All rights reserved.

This publication pertains to Sybase software and to any subsequent release until otherwise indicated in new editions or technical notes. Information in this document is subject to change without notice. The software described herein is furnished under a license agreement, and it may be used or copied only in accordance with the terms of that agreement.

Upgrades are provided only at regularly scheduled software release dates. No part of this publication may be reproduced, transmitted, or translated in any form or by any means, electronic, mechanical, manual, optical, or otherwise, without the prior written permission of Sybase, Inc.

Sybase trademarks can be viewed at the Sybase trademarks page at <http://www.sybase.com/detail?id=1011207>. Sybase and the marks listed are trademarks of Sybase, Inc. ® indicates registration in the United States of America.

SAP and other SAP products and services mentioned herein as well as their respective logos are trademarks or registered trademarks of SAP AG in Germany and in several other countries all over the world.

Java and all Java-based marks are trademarks or registered trademarks of Oracle and/or its affiliates in the U.S. and other countries.

Unicode and the Unicode Logo are registered trademarks of Unicode, Inc.

All other company and product names mentioned may be trademarks of the respective companies with which they are associated.

Use, duplication, or disclosure by the government is subject to the restrictions set forth in subparagraph (c)(1)(ii) of DFARS 52.227-7013 for the DOD and as set forth in FAR 52.227-19(a)-(d) for civilian agencies.

Sybase, Inc., One Sybase Drive, Dublin, CA 94568.

# Contents

<b>New Features v16.5</b> .....	<b>1</b>
New Core Features v16.5 .....	1
New SAP Platform Features v16.5 .....	5
New Business Process Model Features v16.5 .....	8
New Data Model Features v16.5 .....	8
New XML Model Features v16.5 .....	9
<b>New Features v16.1</b> .....	<b>11</b>
New Core Features v16.1 .....	11
New Data Model Features v16.1 .....	16
New Data Movement Model Features v16.1 .....	16
<b>New Features v16.0</b> .....	<b>19</b>
New Core Features v16.0 .....	19
New Symbol Features v16.0 .....	23
New Data Model Features v16.0 .....	25
New PowerDesigner Portal Features v16.0 .....	26
<b>New Features v15.3</b> .....	<b>29</b>
New Core Features v15.3 .....	29
New Business Process Model Features v15.3 .....	30
New Data Model Features v15.3 .....	31
New Repository Features v15.3 .....	32
<b>New Features v15.2</b> .....	<b>33</b>
New Core Features v15.2 .....	33
New Enterprise Architecture Model Features v15.2 .....	35
New Data Model Features v15.2 .....	36
New Data Movement Model Features v15.2 .....	37
New Repository Features v15.2 .....	37
<b>New Features v15.1</b> .....	<b>39</b>
New Core Features v15.1 .....	39
New Project and Framework Features v15.1 .....	41
New Enterprise Architecture Model Features v15.1 .....	41
New Business Process Model Features v15.1 .....	42

## Contents

New Data Model Features v15.1 .....	42
New Data Movement Model Features v15.1 .....	43
New Object-Oriented Model Features v15.1 .....	44
New Repository Features v15.1 .....	44

# New Features v16.5

The following sections describe the new features available in PowerDesigner® v16.5.

## New Core Features v16.5

PowerDesigner v16.5 includes new core features available for all models.

### **Reports**

The PowerDesigner Report Editor has been completely rearchitected to provide a more powerful graphical environment in which to design your model and multi-model reports:

- The synchronized Design and Outline views allow you to work on the detailed content and formatting of report elements in the context of the overall structure.
- Extensions are handled seamlessly in the Toolbox and other views.
- Report item, content and format editing are simplified and easily accessible through the Design view command bar, and changes are instantly visible.
- Titles and free text paragraphs are editable directly in the Design view.
- HTML generation is rebuilt to provide a modern, easily-configurable output.

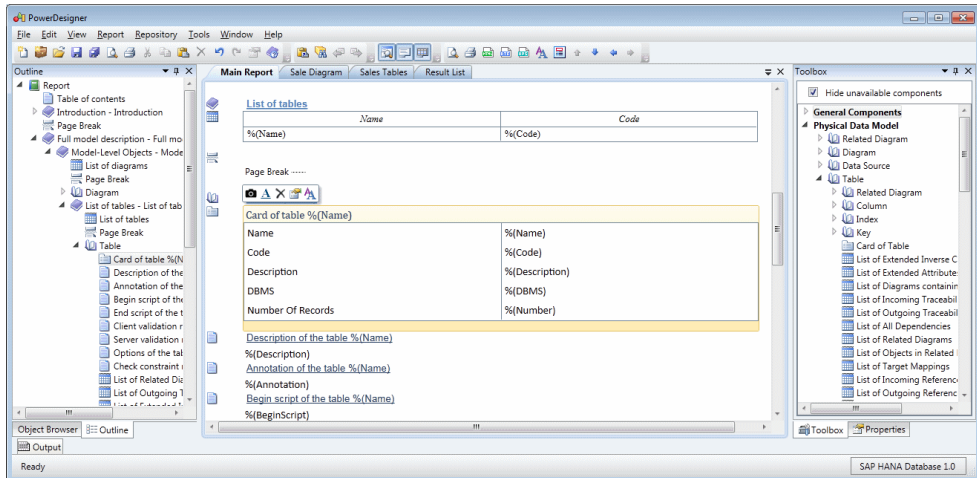

To allow you time to experiment with the new format and editor, and to migrate your existing reports at your chosen pace, this version of PowerDesigner will continue to support the legacy Report Editor, which is now deprecated and will be removed in a future release. This release provides the option to create reports in the new or legacy format, and a simple one-click upgrade is provided to convert existing reports to the new format.

Documented in:

- *Core Features Guide > Storing, Sharing and Reporting on Models > Reports*

### **Change Lists**

The new `Submit` permission provides administrators with finer control over changes to repository documents. Users with this permission, which can be set on a repository folder or model, are required to check their changes into a change list to be reviewed by one or more reviewers instead of writing directly to the location. Users with the `Write` permission can voluntarily check into a change list.

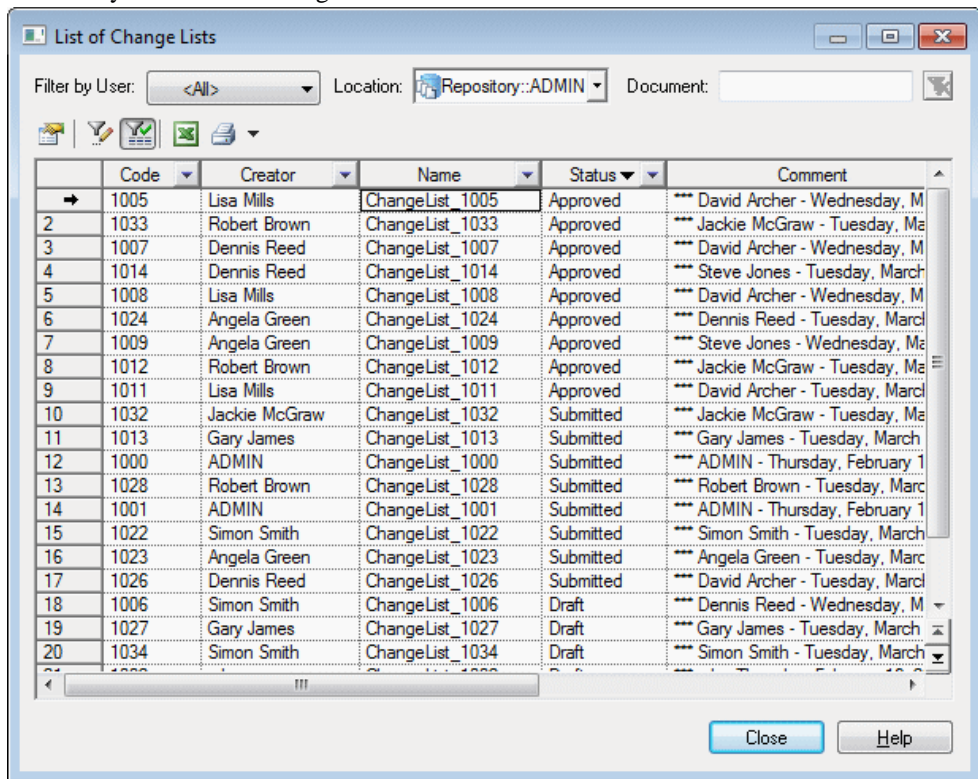

Users can add one or more models or other documents to a change list all at once, or over several check ins. Documents checked into a change list are stored in a special folder in the repository and their contents are not available to other users until they have been approved.

Documented in:

- *Core Features Guide > Storing, Sharing and Reporting on Models > The Repository > Change Lists*

### **Importing XML Files**

You can now import objects from an XML file by defining mappings between the elements in the XML schema and objects in the PowerDesigner metamodel (and extensions). The import

mappings are defined in an extension file, can be shared with all users through the repository library, and are accessed by selecting **File > Import > Import Name**.

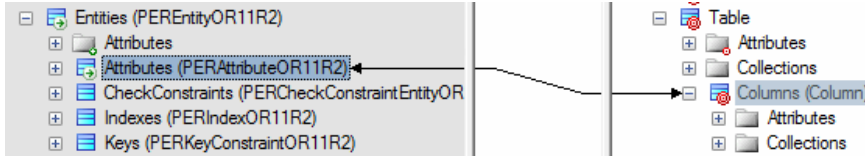

Documented in:

- *Core Features Guide > Modeling with PowerDesigner > Objects > Importing Objects from XML Files*

### **Object Generation Enhancements**

You can now define advanced object generations to generate one or more types of object to any other types of object, with complete control over how all the attributes, compositions (sub-objects), and aggregations (related objects) will be mapped to the generated objects' properties. The generation mappings are defined in an extension file, can be shared with all users through the repository library, and are accessed by selecting **Tools > Generate Objects > Generation Name**.

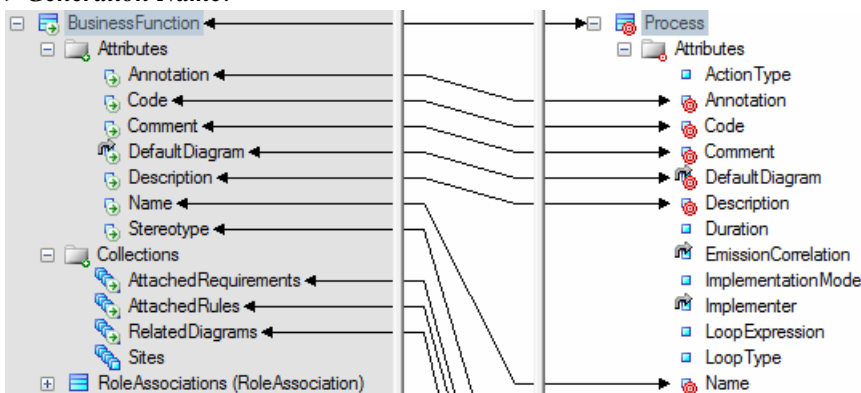

Documented in:

- *Core Features Guide > Linking and Synchronizing Models > Generating Models and Model Objects*

### **Repository Branch Enhancements**

The new branching mechanism introduced in v16.1 has been enhanced to provide:

- A branch filter in the Browser Repository tab:

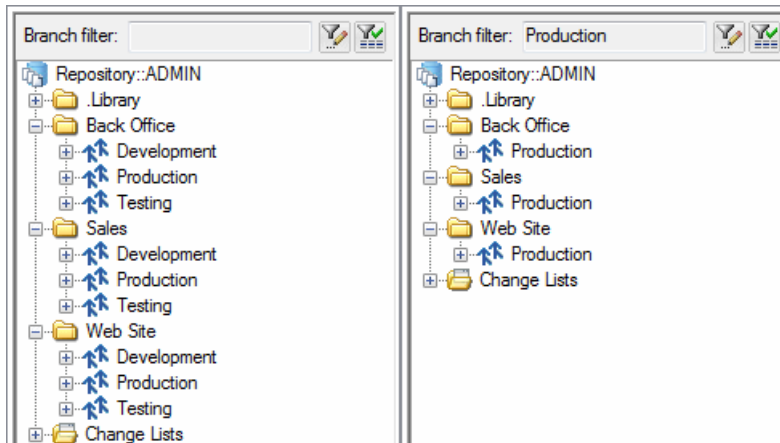

- Model permissions per branch.

Documented in:

- *Core Features Guide > Storing, Sharing and Reporting on Models > The Repository > Branching Version Trees*

### **PowerDesigner Portal Enhancements**

The following enhancements have been made to the PowerDesigner Portal:

- Branch filtering in the Repository Explorer.
- Support for change lists.

Documented in:

- *Core Features Guide > Storing, Sharing and Reporting on Models > The PowerDesigner Portal*

### **Repository Local Model Cache**

A new local cache on your workstation is provided to speed up checking models into and out of the repository.

Documented in:

- *Core Features Guide > Modeling with PowerDesigner > Customizing Your Modeling Environment > General Options > Repository Options*

### **Up-to-Dateness of Shortcuts Visible in Browser**

The models listed in the Target Models category of the Browser now display status icons to indicate whether a newer version is available in the Repository.

Documented in:



- *Core Features Guide > Linking and Synchronizing Models > Shortcuts and Replicas > Working with Target Models*

## New SAP Platform Features v16.5

PowerDesigner v16.5 includes new support for SAP platform solutions.

### **SAP HANA**

PowerDesigner supports modeling and round trip reverse-engineering and generation of SAP HANA® Database v1.0 SP5 tables and analytic and attribute views.

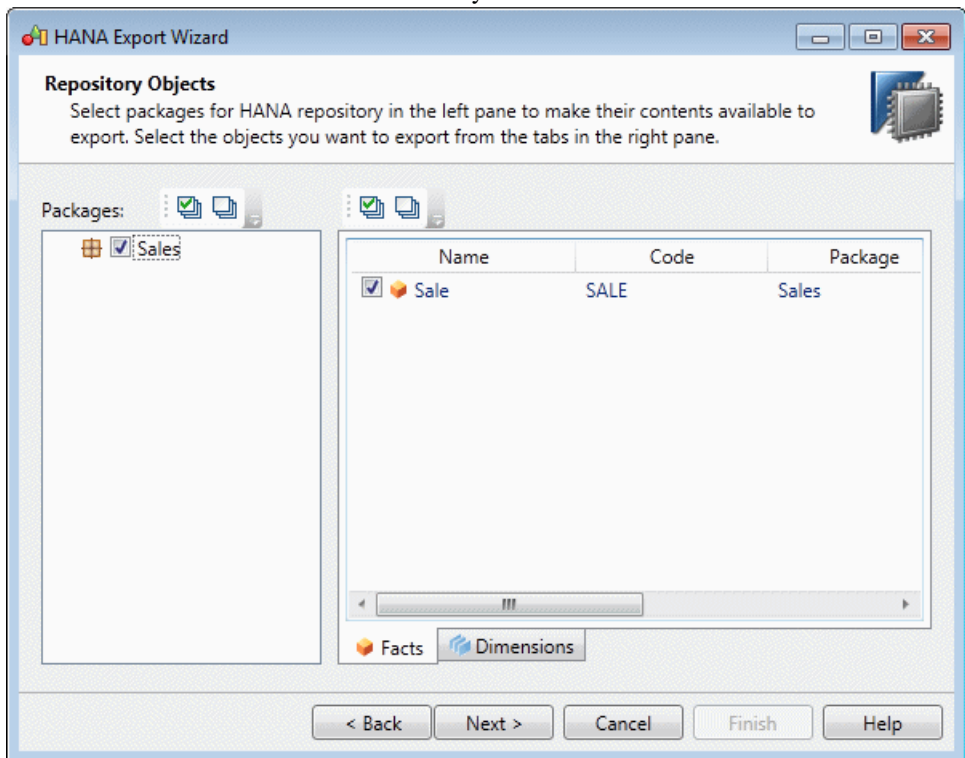

Documented in:

- *Data Modeling > DBMS Definition Reference > SAP HANA Database*

### **SAP BusinessObjects**

PowerDesigner supports generation of a SAP® BusinessObjects™ universe from your PDM for editing in the BusinessObjects Universe Design or Information Design tools, or for direct consumption by the Web Intelligence rich client. Generating a universe from your PDM gives you access to table, view, and column names and comments and more reliable cardinality information than if you create a universe directly from your database.

## New Features v16.5

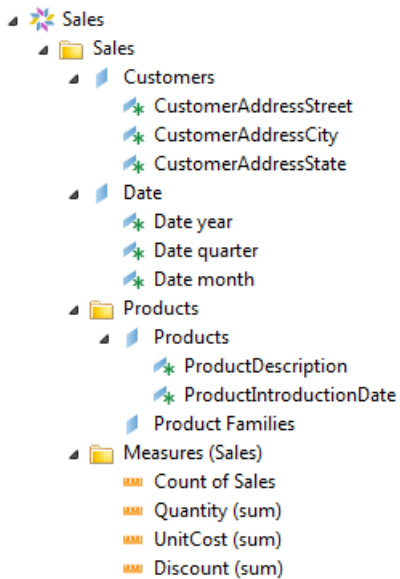

Documented in:

- *Data Modeling > Building Data Models > Generating and Reverse-Engineering Databases > Generating a BusinessObjects Universe*

### **SAP Solution Manager**

PowerDesigner supports modeling and round trip reverse-engineering and generation of SAP® Solution Manager v7.1 business processes.

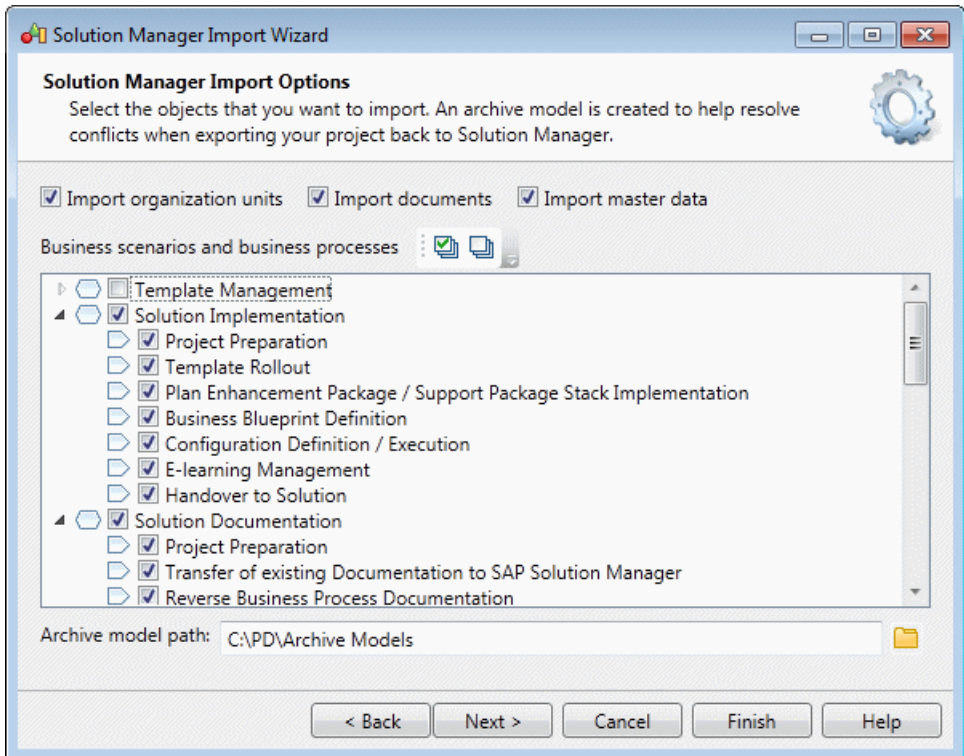

Documented in:

- *Business Process Modeling > Process Language Definition Reference > SAP Solution Manager*

### **SAP NetWeaver**

PowerDesigner supports modeling and round trip reverse-engineering and generation of BPMN2 files, with a particular emphasis on supporting SAP NetWeaver® v7.3 and higher, SAP Streamwork tools, and the Eclipse BPMN2 Modeler.

Documented in:

- *Business Process Modeling > Process Language Definition Reference > Business Process Modeling Notation (BPMN)*

## New Business Process Model Features v16.5

---

PowerDesigner v16.5 includes new features for the Business Process Model (BPM).

### *BPMN 2.0 Enhancements*

PowerDesigner supports modeling and round trip reverse-engineering and generation of BPMN2 files, with a particular emphasis on supporting SAP NetWeaver v7.3 and higher, SAP Streamwork tools, and the Eclipse BPMN2 Modeler.

Documented in:

- *Business Process Modeling > Process Language Definition Reference > Business Process Modeling Notation (BPMN)*

### *SAP Solution Manager*

PowerDesigner supports modeling and round trip reverse-engineering and generation of Solution Manager v7.1 business processes.

Documented in:

- *Business Process Modeling > Process Language Definition Reference > SAP Solution Manager*

## New Data Model Features v16.5

---

PowerDesigner v16.5 includes new features for the Physical Data Model (PDM).

### ***Improved Cube Support***

The PowerDesigner metamodel for cubes has been refined and extended to simplify modeling of multidimensional objects.

Documented in:

- *Data Modeling > Building Data Models > Multidimensional Diagrams*

### ***New or Enhanced DBMS Support***

The following DBMS versions are added:

- SAP HANA Database v1.0 SP5 (see *New SAP Platform Features v16.5* on page 5)
- IBM DB2 for Common Server v9x - Federated System support
- Sybase SQL Anywhere v16.0
- Microsoft SQL Server 2012
- Green Plum 4.2 (not certified, not documented)

Documented in:

- *Data Modeling > DBMS Definition Reference*

## New XML Model Features v16.5

PowerDesigner v16.5 includes new features for the XML Model (XSM).

### ***Reverse-Engineering Enhancements***

The reverse-engineering mechanism has been completely re-architected to support reverse engineering of both local files and URLs, including multiple schemas connected through Import and Include elements. File dependencies are displayed in a tree form, and any file can be substituted for an appropriate other file or URL or by an existing XML model:

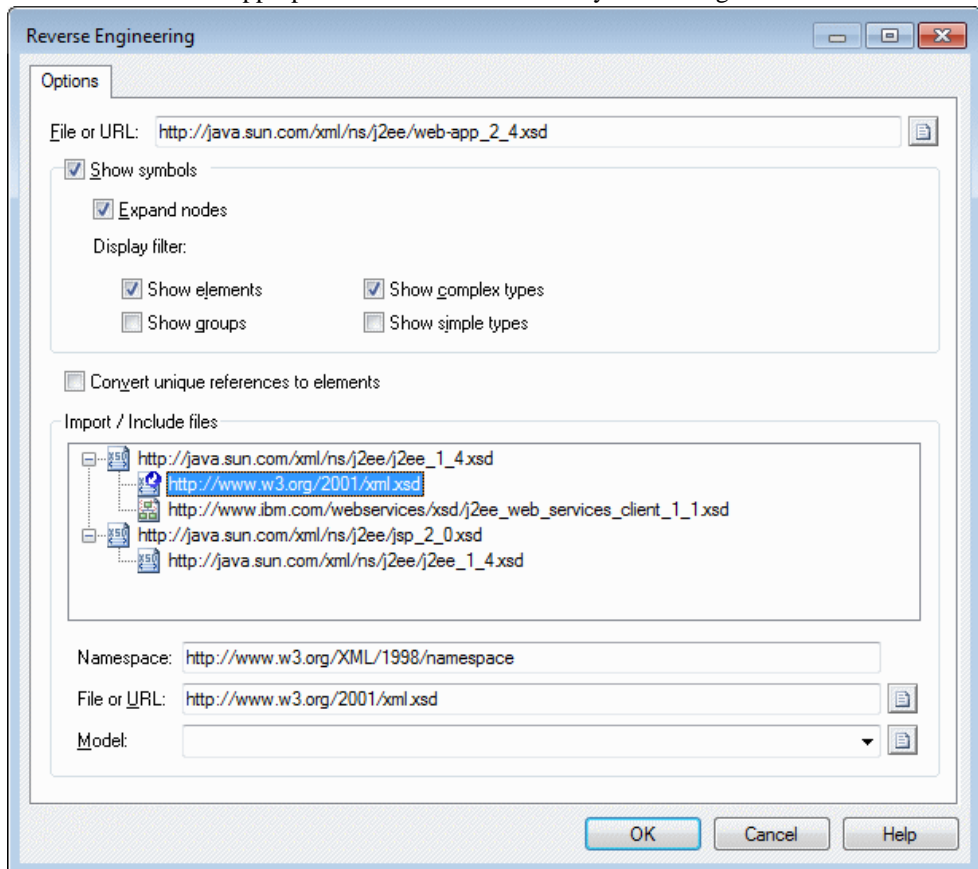

Each schema is imported as a separate XML model with appropriate shortcuts connecting them.

Documented in:

- *XML Modeling > Generating and Reverse Engineering XML Schemas and Other Models*

### **Complex Type Enhancements**

XSM support for complex types has been enhanced to provide the following:

- Elements typed with a complex type deploy the complex type and child elements on their symbols.
- Mappings can be created to or from individual instances of the complex type in the Mapping Editor.
- Shortcuts to complex types in other models can be displayed and mapped to in the Mapping Editor.

Documented in:

- *XML Modeling > XML Diagrams > Complex Types (XSM)*

### **XML Model Generation Enhancements**

New global generation options support generating PDM tables and OOM classes as elements with or without complex types and PDM columns and OOM attributes as elements or attributes, while object-by-object generation settings are supported through an extension.

Documented in:

- *Core Features Guide > Linking and Synchronizing Models > Generating Models and Model Objects*

# New Features v16.1

The following sections describe the new features available in PowerDesigner® v16.1.

## New Core Features v16.1

---

PowerDesigner v16.1 includes new core features available for all models.

### **Repository Branch Enhancements**

Branches in the repository have been completely re-architected to allow:

- The simultaneous display of all branches in the repository browser:

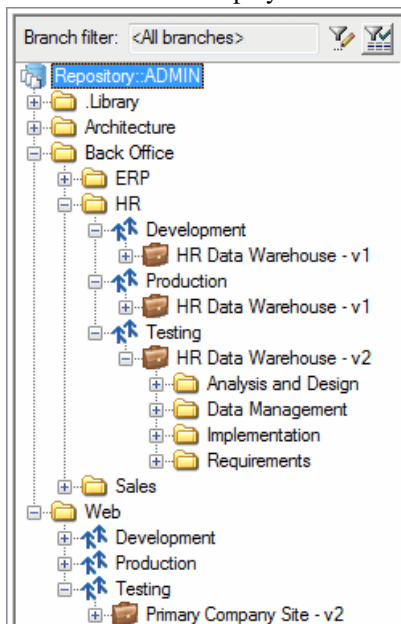

- Branching on a folder-by-folder basis.
- Simplified version numbering
- Greater flexibility and control over branch contents
- Simplified integration of changes from one branch to another.

Documented in:

- *Core Features Guide > Storing, Sharing and Reporting on Models > The Repository > Branching Version Trees*

### **Local Browser Filter**

The Local tab of the Browser now includes a filter. To filter the Browser tree, start typing the name of an object that you want to find in the Filter box:

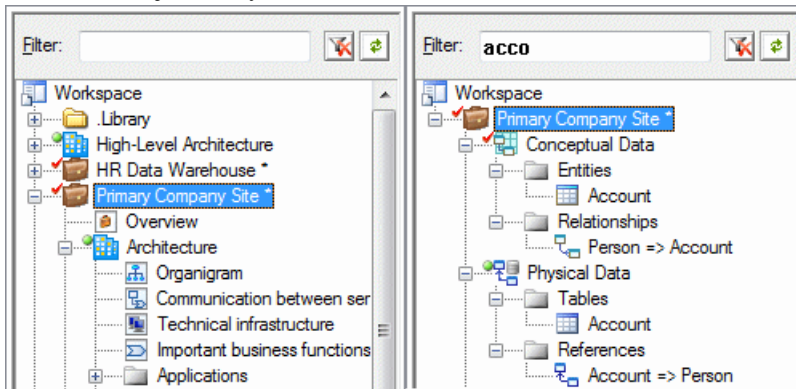

Documented in:

- *Core Features Guide > Modeling with PowerDesigner > The Browser*

### **Enterprise Glossary Enhancements**

The glossary has been enhanced to provide:

- A single view with integrated filtering of all objects supported by the glossary:

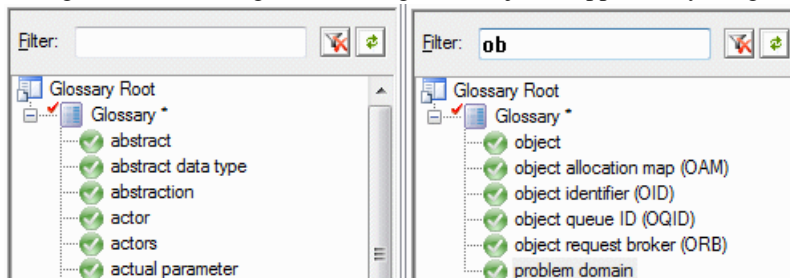

- Glossary terms lists - which present terms and their definitions in a filterable list format in the canvas.
- Support for creating list reports and dependency matrixes in the glossary.
- New model checks on the model and packages to summarize all the terms in object names that are not in the glossary and which allow users with the appropriate permissions to merge these missing terms into the glossary.

Documented in:

- *Core Features Guide > Modeling with PowerDesigner > The Browser > The Glossary*
- *Core Features Guide > Administering PowerDesigner > Deploying an Enterprise Glossary and Library*



**Enterprise Library Enhancements**

The library now supports pushing DBMS and language definition files, extensions, and other resource files to users. Resource files synchronized through the library are automatically included in resource file lists, the New Model dialog, and anywhere where a resource file can be selected.

Documented in:

- *Core Features Guide > Modeling with PowerDesigner > The Browser > The Library*
- *Core Features Guide > Administering PowerDesigner > Deploying an Enterprise Glossary and Library*

**Security Enhancements**

Repository and database security is enhanced as follows:

- A password is now required to connect to the repository, and connection passwords are not saved locally.
- Administrators have granular control over the complexity and lifetime of passwords via a password policy:

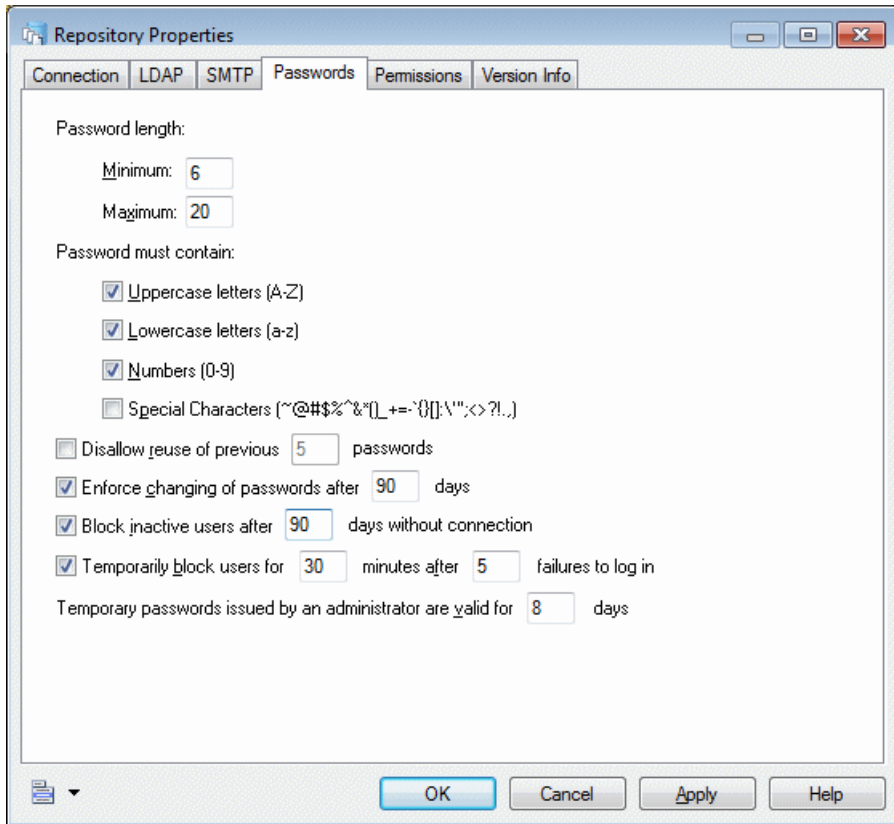

- All communication between the PowerDesigner client and the repository proxy are encrypted. Communications between the proxy and the repository server or between PowerDesigner and a database via ODBC or JDBC can be encrypted if the driver supports it.
- In the event that no administrator is able to log in to a running repository, it is now possible to create an emergency administrator account to regain access.

Documented in:

- *Core Features Guide > Administering PowerDesigner > Controlling Repository Access*

### **PowerDesigner Portal Enhancements**

The following enhancements have been made to the PowerDesigner Portal:

- Quick search is now available on all PowerDesigner Portal tabs.
- Rich text editing is now supported directly in the PowerDesigner Portal, including support for creating and editing tables, images, and hyperlinks.
- Support for modifying the new repository password policy.

Documented in:

- *Core Features Guide > Storing, Sharing and Reporting on Models > The PowerDesigner Portal*

### **IPv6 Support**

PowerDesigner now supports communication between client machines and the repository or proxy in IPv6 environments and in mixed IPv4/IPv6 environments.

### **Multiple Paths in Resource Lists**

You can now specify multiple paths for each type of resource file, and PowerDesigner will search all of these paths and combine the results in order to populate resource file lists.

Documented in:

- *Core Features Guide > Modeling with PowerDesigner > Customizing Your Modeling Environment > PowerDesigner Resource Files*

### **Symbol Improvements**

The following enhancements are provided for working with symbols:

- The **Keep size** format option can now be applied to composite symbols so that they do not expand, even when you create additional sub-objects inside them.
- The three labels that can be displayed at the source, center, and destination of link symbols can now be resized independently. To revert to the default word-wrapping, select the label and press **Ctrl+J**.

Documented in:

- *Core Features Guide > Modeling with PowerDesigner > Diagrams, Matrices, and Symbols > Symbols > Symbol Format Properties*

### **Reports Support SVG Generation for HTML5-Compliant and Older Browsers**

PowerDesigner now supports generating SVG diagrams in reports for both HTML5-compliant and older browsers. You should specify the primary type of browser that will be used to view your HTML report in the report property sheet.

Documented in:

- *Core Features Guide > Storing, Sharing and Reporting on Models > Reports > The Report Editor > Report Properties*

### **Shortcut Improvements**

The improvements made to external shortcuts from one model to another, which allow them to display all the properties of their source object even when its model is closed or unavailable, are now provided for the XML model (XSM) in addition to all the other model types.

Documented in:

- *Core Features Guide > Linking and Synchronizing Models > Shortcuts and Replicas*

### **Metaclasses Defined in Extensions in Permissions Profiles**

You can now control the availability of metaclasses defined in a DBMS, language definition, or extension file with a permission profile.

Documented in:

- *Core Features Guide > Administering PowerDesigner > Customizing the PowerDesigner Interface > Using Profiles to Control the PowerDesigner Interface*

## **New Data Model Features v16.1**

---

PowerDesigner v16.1 includes new features for the Physical Data Model (PDM).

### **Sybase IQ Reference Architecture Sizing**

The advisor wizard now supports modeling for logical servers for Sybase® IQ v15.3 and v15.4 and also allows you to specify different hardware profiles for the reader, writer, and coordinator nodes.

Documented in:

- *Enterprise Architecture Modeling > Sybase IQ Reference Architecture Model*

### **New or Enhanced DBMS Support**

The following DBMS versions are added:

- Sybase IQ v15.3 and v15.4

Documented in:

- *Data Modeling > DBMS Definition Reference*

## **New Data Movement Model Features v16.1**

---

PowerDesigner v16.1 includes new features for the Data Movement Model (DMM).

### **Replication Server® v15.7**

Replication Server v15.7 and higher supports multi-path replication of Adaptive Server Enterprise v15.7 and higher primary databases to increase replication throughput and performance, and reduce contention. PowerDesigner provides support for multi-path replication by letting you:

- Draw multiple parallel connections between a database and replication server and specify which is the default path.
- Specify logical connections to distribute data and objects bound to a physical path to multiple Replication Servers.

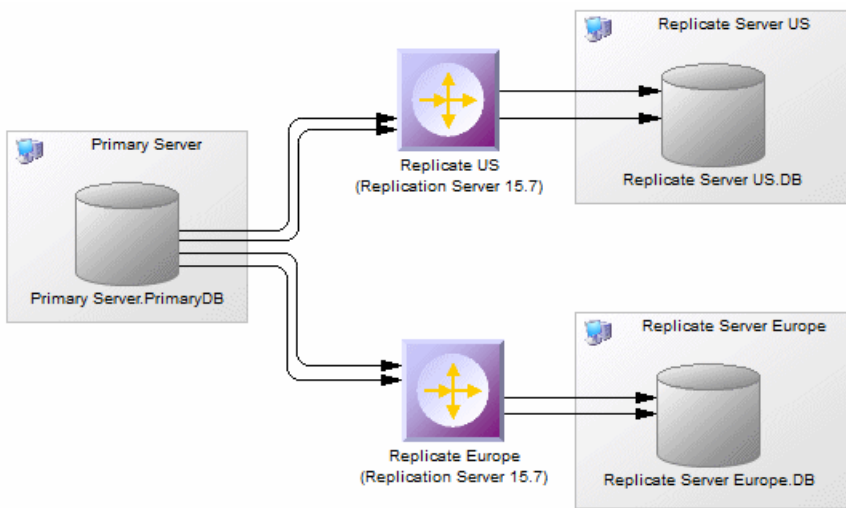

Documented in:

- *Data Movement Modeling > Working with Replication Server*



# New Features v16.0

The following sections describe the new features available in PowerDesigner® v16.0.

**Note:** The documentation for the repository has been moved to the Core Features Guide in this version. In addition, a new Quick Reference guide, which provides an overview of core and module-specific features, is available as a PDF and as part of the online help collection.

## New Core Features v16.0

PowerDesigner v16.0 includes new core features available for all models.

### ***New Interface***

The code underpinning the PowerDesigner interface has been rewritten to provide a contemporary look and feel.

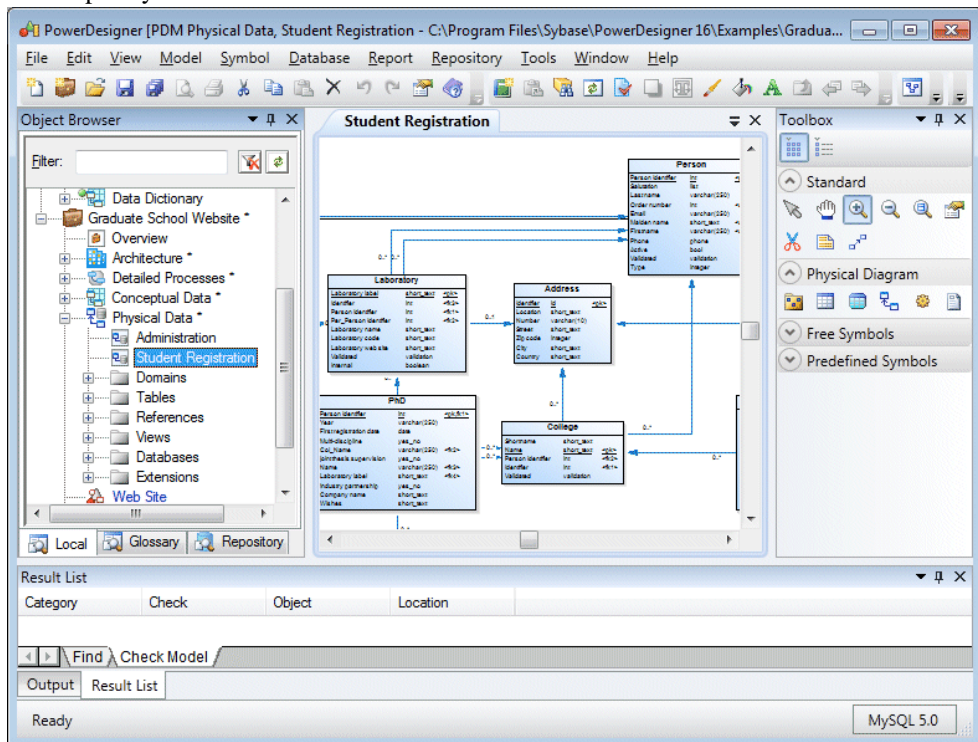

The new environment provides:

- A dockable toolbox with an autohide option, list and icon modes, and collapsible sections.

## New Features v16.0

- Tabbed diagram views
- Full customization of menus, toolbars, and toolboxes
- Improved window management

Documented in:

- *Core Features Guide > Modeling with PowerDesigner > Customizing Your Modeling Environment*

### **Enterprise Glossary**

In environments with a repository, administrators can deploy an enterprise glossary of terms approved for use in your environment to a special repository folder, which pushes the glossary to users to help ensure enterprise-wide consistency.

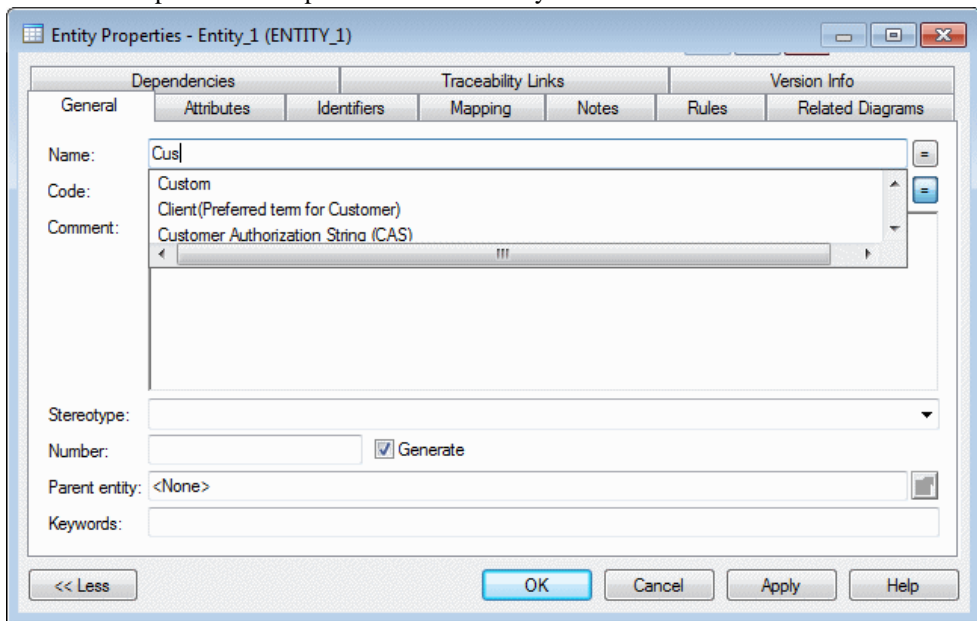

Users automatically receive updates to the glossary whenever they connect to the repository. The glossary is displayed in the Browser **Glossary** tab and, when enabled in a model, provides auto-completion for object names and codes, and model checks to measure and encourage glossary compliance.

Documented in:

- *Core Features Guide > Modeling with PowerDesigner > The Browser > The Glossary*

### **Enterprise Library**

In environments with a repository, administrators can deploy an enterprise library of reference models to a special repository folder, which pushes them to users to help ensure enterprise-wide consistency.



Users automatically receive updates to the library models whenever they connect to the repository. The library is displayed in a special folder in the Browser **Local** tab, and users can create shortcuts to and replications of these enterprise objects in their project models.

Documented in:

- *Core Features Guide > Modeling with PowerDesigner > The Browser > The Library*

### ***Role-Based Interface Customization***

In environments with a repository, administrators can now use powerful profiles to customize and simplify the PowerDesigner interface for different kinds of users.

You can develop object permissions profiles to hide models, objects, and properties, or make models available in read-only form. In addition, you can develop UI and general preferences profiles to set defaults for menus, toolbars, and toolboxes, options and preferences.

These profiles are associated with users and groups in the repository and pushed to users to provide role-based customization of the PowerDesigner environment.

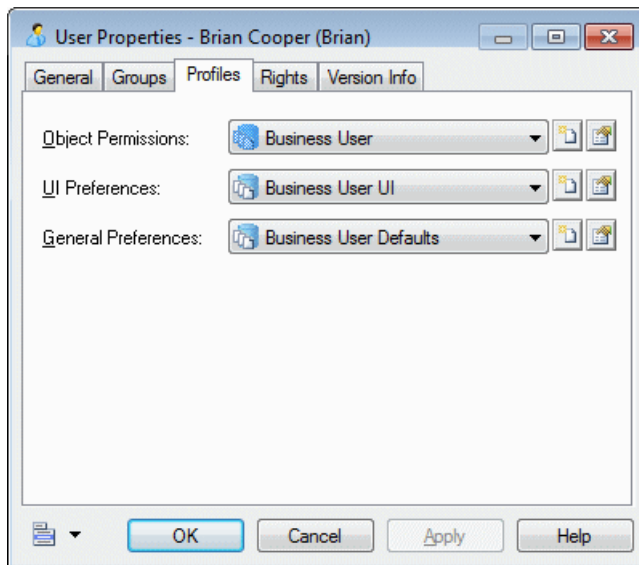

---

**Note:** This feature is not supported for the XML model (XSM).

---

Documented in:

- *Core Features Guide > Administering PowerDesigner > Customizing the PowerDesigner Interface*

### ***Impact Analysis Enhancements***

Enhancements to impact analysis now allow you to launch an analysis from a local model and continue finding connected objects in models stored in the repository. You can also launch an analysis on any object in the repository or from the PowerDesigner Portal.

Documented in:

- *Core Features Guide > Linking and Synchronizing Models > Impact and Lineage Analysis*

### **Shortcut Improvements**

External shortcuts from one model to another now display all the properties of their source object, even when its model is closed or unavailable.

---

**Note:** This feature is not supported for the XML model (XSM).

---

Documented in:

- *Core Features Guide > Linking and Synchronizing Models > Shortcuts and Replicas > Creating Shortcuts > Shortcut Properties*

### **Customizing Property Sheets**

In addition to the already rich customization available for object property sheets, you can now:

- Replace any standard property sheet tab
- Include forms within forms
- Create property sheet tabs containing sub-tabs

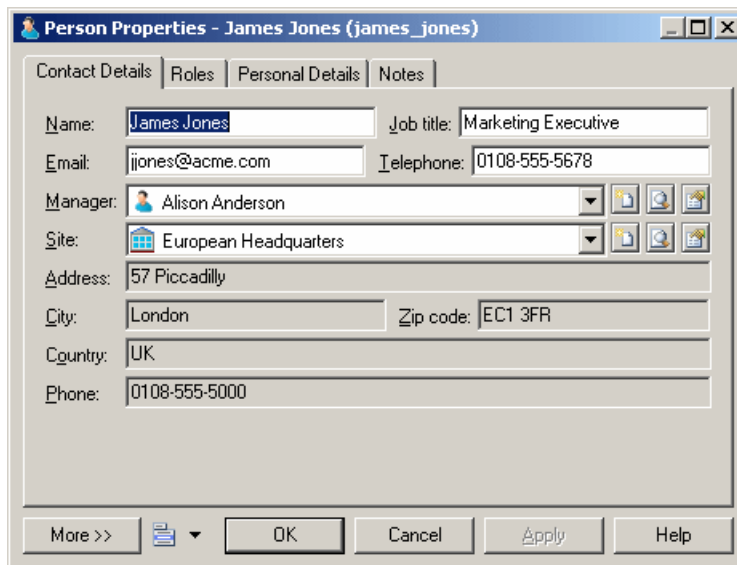

Documented in:

- *Customizing and Extending PowerDesigner > Extension Files > Forms (Profile)*

### **Extended Dependency Renaming and Enhancements**

Extended dependencies are renamed as "traceability links". The new links allow you to create links between any kinds of object, to specify new types of links, and to group links by object type or by link type in the **Traceability Links** tab of each object property sheet.

Documented in:

- *Core Features Guide > Linking and Synchronizing Models > Getting Started with Linking and Syncing > Creating Traceability Links*

### **New Environments**

The following new environments are supported:

- Windows 64-bit versions
- Eclipse v3.6
- Microsoft Office 2010 and Visio 2010 - import add-ins

## **New Symbol Features v16.0**

PowerDesigner v16.0 includes new features for symbols available for all models.

### **Enhanced Symbol Editing**

You can now edit most object properties directly from diagram symbols. You can also add, edit, and delete sub-objects, and drag and drop sub-objects from one symbol to another.

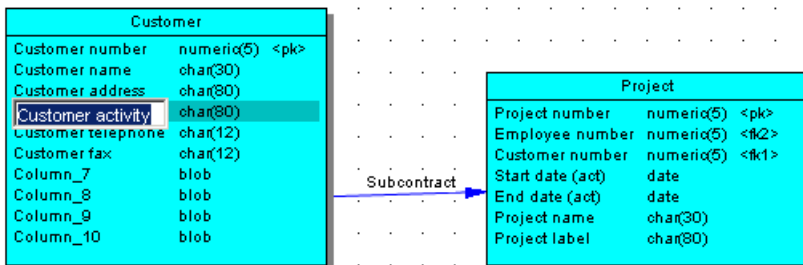

Documented in:

- *Core Features Guide > Modeling with PowerDesigner > Diagrams, Matrices, and Symbols > Symbols*

### **Horizontal and Vertical Symbol Layouts**

New options provide greater flexibility for organizing properties on symbols, allowing multiple properties on a line and columns of properties.

Account (250) (Generated)		
Login	Variable characters (250) <M>	For connecting to a computer system.
Password	Variable characters (250) <M>	
Administrator	Boolean	

Documented in:

- *Core Features Guide > Modeling with PowerDesigner > Diagrams, Matrices, and Symbols > Display Preferences*

**Attribute Value Icons**

You can now create sets of icons to represent extended attribute values on diagram symbols. In the following example, each entity symbol displays an icon at its top-right corner to indicate progress:

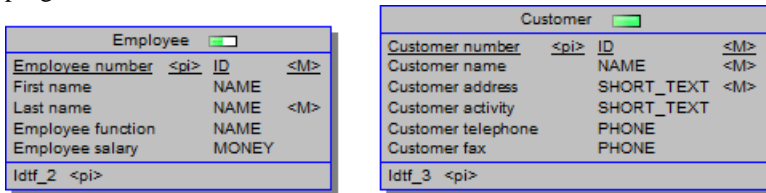

Documented in:

- *Customizing and Extending PowerDesigner > Extension Files > Extended Attributes (Profile) > Specifying Icons for Attribute Values*

**Automatic Link Routing and Link Bridges**

Most diagrams now support a new algorithm for automatically optimizing link paths and routing them around object symbols. When link paths must cross, a bridge or "line hop" is added to clarify the flows.

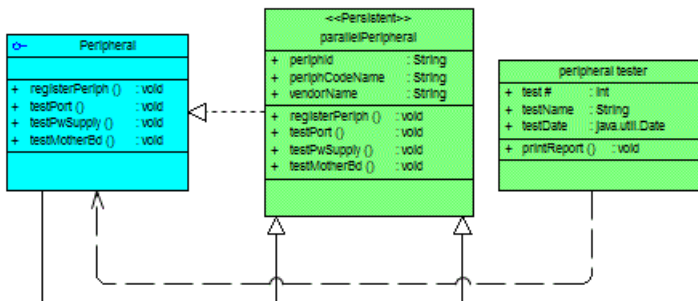

---

**Note:** These display preferences are enabled by default for new models, but need to be set manually for models created in previous versions of PowerDesigner.

---

Documented in:

- *Core Features Guide > Modeling with PowerDesigner > Diagrams, Matrices, and Symbols > Symbols*

## New Data Model Features v16.0

PowerDesigner v16.0 includes new features for the Physical Data Model (PDM).

### ***Sybase IQ Reference Architecture Sizing***

PowerDesigner now provides a special EAM model to help you determine the architecture required to deploy a Sybase® IQ data warehouse solution to meet your anticipated workload. An advisor wizard generates architectures based on one or more hardware servers, and comparison tools help you choose the best architecture based on your requirements for cost and speed.

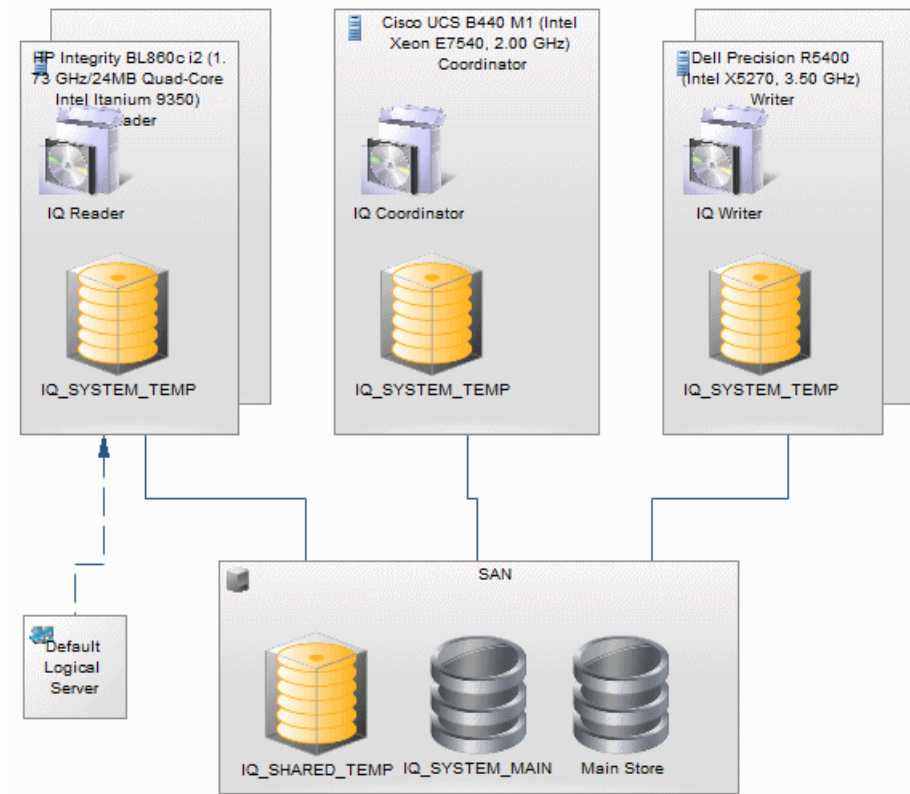

Documented in:

- *Enterprise Architecture Modeling > Sybase IQ Reference Architecture Model*

### ***Customizable Data Type Mapping***

When changing DBMS or generating one PDM from another, you can now specify mappings of data types down to the individual column level.

## New Features v16.0

Documented in:

- *Data Modeling > Building Data Models > Generating Other Models from a Data Model > Generating Other Models from a PDM > Customizing Data Type Mappings*

### **New or Enhanced DBMS Support**

The following DBMS versions are added or enhanced:

- DB2 UDB v9.7 for Common Server
- DB2 v10.x for z/OS
- Netezza v5.0
- MS Access 2007 and 2010
- MS SQL Server 2008 R2 (supported via the MS SQL Server 2008 DBMS definition file)
- Sybase Adaptive Server Enterprise v15.7

Documented in:

- *Data Modeling > DBMS Definition Reference*

## New PowerDesigner Portal Features v16.0

PowerDesigner v16.0 includes new features for the PowerDesigner Portal.

### **Quick Search**

A new Quick Search bar is available at the top of the Search page, which allows you to search directly on names, codes, and other fields of type string or text without the complexity of setting up a query.

account AND NOT admin Quick search

Search in: / Advanced search

Back pdf Report All Properties Search within Results 123 results.

Name	Object Type	Resource Path	Text View
Account	Table	/Web/Production/Primary Company Site/Physical Data	Code:Account Name:Account
Account	Edition	/Web/Testing/Primary Company Site/Web Site	Code:Account Name:Account
Account	Class	/Back Office/HR/Testing/HR Data Warehouse/Implementation/WebLibrary Java Implementation	Name:Account Code:Account
Account	Class	/Back Office/HR/Development/HR Data Warehouse/Implementation/WebLibrary Java Implementation	Code:Account Name:Account
Account	Class	/Back Office/HR/Development/HR Data Warehouse/Analysis and design/WebLibrary Design	Code:Account Name:Account
Account	Article	/Back Office/HR/Testing/HR Data Warehouse/Data Management/Data ETL and Replication	Remote Table:DUPLICATED_ACCOUNT Name:Account Code:ACCOUNT
Account	Entity	/Back Office/HR/Development/HR Data Warehouse/Analysis and design/WebLibrary Conceptual Data	Name:Account Code:ACCOUNT
Account	Class	/Back Office/HR/Testing/HR Data Warehouse/Analysis and Design/WebLibrary Design	Name:Account Code:Account
Account	List	/Web/Development/Primary Company Site/Web Site	Name:Account

2 3 4 5 Show properties Page: 1 Go

Documented in:

- *Core Features Guide > Storing, Sharing and Reporting on Models > The PowerDesigner Portal > PowerDesigner Portal Search*

### **Editing Comments, Descriptions, and Annotations**

Users with the new PowerDesigner Portal Composer license can now edit the comments, descriptions, and annotations of objects directly in the PowerDesigner Portal.

Documented in:

- *Core Features Guide > Storing, Sharing and Reporting on Models > The PowerDesigner Portal > PowerDesigner Portal Repository Explorer > Editing Object Comments and Descriptions*

### **Impact Analysis**

Impact and lineage analysis is now available on the **Analysis** tab of the property sheet of all objects in the PowerDesigner Portal Repository Explorer.

Documented in:

- *Core Features Guide > Storing, Sharing and Reporting on Models > The PowerDesigner Portal > PowerDesigner Portal Repository Explorer > Impact and Lineage Analysis in the PowerDesigner Portal*





# New Features v15.3

The following sections describe the new features available in PowerDesigner® v15.3.

---

**Note:** The Information Liquidity Model (ILM) was renamed to Data Movement Model (DMM) in this version.

---

## New Core Features v15.3

---

PowerDesigner v15.3 includes new core features available for all models.

### *Object List Enhancements*

The following enhancements are available in object lists:

- Export list to Excel
- Print list with WYSIWYG preview
- Rapid in-column filtering
- Customize columns in lists containing multiple types of objects

Documented in:

- *Core Features Guide > Modeling with PowerDesigner > Objects > Object Lists*

### *Create Diagram from Selection*

You can now create a new diagram from a selection of symbols using the new **Create Diagram from Selection** command.

Documented in:

- *Core Features Guide > Modeling with PowerDesigner > Diagrams, Matrices, and Symbols > Diagrams > Creating a Diagram*

### *Create Related Diagrams*

You can now create a new related diagram for an object directly from the **Related Diagram** tab or using the new **Related Diagram** submenu.

Documented in:

- *Core Features Guide > Modeling with PowerDesigner > Diagrams, Matrices, and Symbols > Diagrams > Specifying Diagrams as Related Diagrams*

### *Multi-Selection in Matrices*

You can now select and modify multiple cells in matrices.

Documented in:

## New Features v15.3

- *Core Features Guide > Modeling with PowerDesigner > Diagrams, Matrices, and Symbols > Dependency Matrices*

### *Display Preferences*

All PowerDesigner diagrams now have completely customizable display preferences, which allow you to display any of their attributes and collections in any order that you want on their diagram symbols.

In addition, the interface has been simplified to make access to format and content preferences available on tabs in a single dialog.

Documented in:

- *Core Features Guide > Modeling with PowerDesigner > Diagrams, Matrices, and Symbols > Display Preferences*

### *UI Simplifications*

The PowerDesigner user interface has been simplified in the following areas:

- The Share and Copy radio buttons on the New Model dialog and in other parts of the interface are replaced by a single **Embed Resource in Model** tool.
- The Merge Models now displays a single tree view showing the anticipated result of the merge. You can revert to the former double-tree view format by clicking the **Show Source Model** button at the top left of the pane.

### *Plugin Support*

The PowerDesigner plugin for Visual Studio now supports Visual Studio 2010.

---

## **New Business Process Model Features v15.3**

---

PowerDesigner v15.3 includes new features for the Business Process Model (BPM).

### *BPMN 2.0*

PowerDesigner now provides support for modeling business processes in BPMN 2.0 conversation diagrams, choreography diagrams, collaboration diagrams, and process diagrams.

Documented in:

- *Business Process Modeling > Process Language Definition Reference > Business Process Modeling Notation (BPMN)*

### *Message Format Linked to XSM*

You can now use an XML model (XSM) to model the definition of a message format

Documented in:

- *Business Process Modeling > Building BPMs > Business Process Diagrams > Message Formats (BPM)*

## New Data Model Features v15.3

---

PowerDesigner v15.3 includes new features for the Physical Data Model (PDM).

### *Sybase IQ Information Lifecycle Management*

Support for information lifecycle management is extended to handle the movement of indexes associated with the tables managed by the lifecycle. In addition, an improved lifecycle property sheet now displays all the elements required to define a lifecycle on a single tab.

Documented in:

- *Data Modeling > Building Data Models > Physical Implementation > Lifecycles (PDM)*

### *Estimate Database Size Enhancements*

The Estimate Database Size mechanism now includes support for the growth in size of a database over a period of years, and the estimation algorithms can be customized through scripts in the DBMS definition file.

Documented in:

- *Data Modeling > Building Data Models > Generating and Reverse-Engineering Databases > Generating a Database from a PDM > Estimating Database Size*

### *Data Profiling Enhancements*

Data profiling constraints have been enhanced to provide better case support and reuse of test data profiles, and data formats can now be reused between multiple objects.

Documented in:

- *Data Modeling > Building Data Models > Physical Diagrams > Columns (PDM) > Setting Data Profiling Constraints*

### *Oracle Database Package Templates*

Database packages can now be defined through a template, so that PowerDesigner will generate packages specific to each table and update them automatically when you make changes to the table definition.

Documented in:

- *Data Modeling > DBMS Definition Reference > Oracle > Database Packages (Oracle) > Database Package Templates*

### *Metamodel Enhancements*

The PDM metamodel has been simplified to provide better support for schemas, materialized views, join indexes, and inner joins.

## New Features v15.3

### *New or Enhanced DBMS Support*

The following DBMS versions are added or enhanced:

- Teradata v13
- HP Neoview
- Sybase SQL Anywhere v12

Documented in:

- *Data Modeling > DBMS Definition Reference*

## **New Repository Features v15.3**

---

PowerDesigner v15.3 includes new features for the Repository.

### *Simplified Check In*

A new simplified check in dialog is available, which hides less frequently used check in options behind an **Advanced** button.

Documented in:

- *Core Features Guide > Storing, Sharing and Reporting on Models > The Repository > Checking Documents into the Repository*

### *PowerDesigner Portal Enhancements*

The following enhancements are available in the PowerDesigner Portal:

- Customizable result columns on Search page
- Navigation through shortcuts to the target object
- Support for downloading external documents (Word etc)
- Customizable custom color themes and logos on the PowerDesigner Portal website
- Lists of sub-objects are now displayed as tabs on the parent object property sheet
- Clicking on a diagram in the Explorer displays the diagram
- Sortable columns can be sorted by clicking on the column header

Documented in:

- *Core Features Guide > Storing, Sharing and Reporting on Models > The PowerDesigner Portal*

# New Features v15.2

The following sections describe the new features available in PowerDesigner® v15.2.

## New Core Features v15.2

---

PowerDesigner v15.2 includes new core features available for all models.

### *Generating Objects to Other Models*

You can now define your own generations of any modeling object to any other modeling object. These new object generations work in the same way as the standard PowerDesigner model generations but are completely configurable and allow you to generate only the objects you need to any kind of model. Generation links between the source and target (generated) objects mean that you can keep the linked models synchronized.

Documented in:

- *Core Features Guide > Linking and Synchronizing Models > Generating Models and Model Objects*

### *Excel Import*

There is new support for importing lists of objects and object properties from Excel spreadsheets to any model type via the **File > Import** menu. A simple wizard walks you through mapping your Excel lists and columns to PowerDesigner objects and properties.

Documented in:

- *Core Features Guide Modeling with PowerDesigner > Objects > Importing Objects from Excel Files*

### *Autosave*

A new option instructs PowerDesigner to autosave your changes to a recovery backup file at a configurable interval to let you recover your work in the event that your modeling session exits abnormally.

Documented in:

- *Core Features Guide Modeling with PowerDesigner > Customizing Your Modeling Environment > General Options*

### *Naming Conventions*

Camel case and headless camel case are now supported for code naming conventions. Changes to name to code conversion scripts can now be applied immediately to currently synchronized (or all) objects.

Documented in:

- *Core Features Guide > Modeling with PowerDesigner > Objects > Naming Conventions*

### *Dependency Matrix Enhancements*

The following enhancements are available for dependency matrices:

- Export the matrix to an Excel file
- Enhanced filtering of rows and columns with persistent filtering
- Vertical column headers available
- Row heights and column widths are persisted
- Extensions now treated as standard objects
- WYSIWYG print preview and improved printing

Documented in:

- *Core Features Guide > Modeling with PowerDesigner > Diagrams, Matrices, and Symbols > Dependency Matrices*

### *More Diagrams with Customizable Display Preferences*

Extended objects, packages, and all the objects in the following kinds of diagrams now have completely customizable display preferences, which allow you to display any of their attributes and collections in any order that you want on their diagram symbols:

- Enterprise Architecture Model - All diagrams
- Business Process Model:
  - Business Process Diagram
  - Process Hierarchy Diagram
- Conceptual Data Model - All diagrams
- Logical Data Model - All diagrams
- Physical Data Model - All diagrams
- Data Movement Model:
  - Transformation Control Flow Diagram
- Object-Oriented Model - All diagrams

Documented in:

- *Core Features Guide > Modeling with PowerDesigner > Diagrams, Matrices, and Symbols > Display Preferences*

### *RTF Formatting Preserved in HTML Reports*

RTF formatting including images, tables, hyperlinks and font formatting are preserved in the generation of HTML reports.

### *New Object Mappings*

Object mappings are now supported in both directions between the following kinds of models:

- LDM-OOM
- LDM-PDM
- LDM-CDM

Documented in:

- *Core Features Guide > Linking and Synchronizing Models > Object Mappings*

### *Improvements to Metamodel Extensions*

Many improvements have been made to PowerDesigner's support for metamodel extensions (see *Customizing and Extending PowerDesigner > Extension Files*), including:

- Exclude standard metaclasses from the interface to simplify your working environment (see *Metaclasses (Profile)*)
- Specify a display label and default columns when displaying a collections as a property sheet tab (see *Extended Collections and Compositions (Profile)*)
- Specify display labels for custom forms and collections in the interface (see *Extended Collections and Compositions (Profile)*)
- Specify a format for text extensions to obtain format-specific editors (see *Extended Attributes (Profile)*)
- Specify a display label for, and associate contextual help with, custom forms (see *Forms (Profile)*)
- Specify icons on tool buttons calling methods on custom forms (see *Forms (Profile) > Adding Extended Attributes and Other Controls to Your Form*)
- Finer-grained control over the format and content of custom symbols (see *Core Features Guide > Modeling with PowerDesigner > Diagrams, Matrices, and Symbols > Symbols > Symbol Format Properties*)

### *New Environments*

The following new environments are supported:

- Windows 7
- Windows 2008 Server
- Eclipse v3.5

## **New Enterprise Architecture Model Features v15.2**

---

PowerDesigner v15.2 includes new features for the Enterprise Architecture Model (EAM).

### *Cluster Servers and Virtual Machines*

You can now model complex machine-in-machine environments using hardware and software servers and workstations.

Documented in:

- *Enterprise Architecture Modeling > Technology Layer Diagrams > Servers, Workstations, Mobile Devices, and Network Nodes (EAM) > Modeling Cluster Servers and Virtual Machines*

## **New Data Model Features v15.2**

---

PowerDesigner v15.2 includes new features for the Conceptual, Logical, and Physical Data Models (CDM, LDM, and PDM).

### *Sentence Generation from Relationships*

English language sentences derived from the roles specified on CDM/LDM relationships between entities are now available on the relationship property sheet, and can be displayed on symbols and in reports.

Documented in:

- *Data Modeling > Building Data Models > Conceptual and Logical Diagrams > Relationships (CDM/LDM) > Relationship Properties*

### *Sybase IQ Information Lifecycle Management*

Support for information lifecycle management is extended to handle access-based lifecycles and movement of pre-lifecycle data.

Documented in:

- *Data Modeling > Building Data Models > Physical Implementation > Lifecycles (PDM)*

### *Batch Import of ERwin Files*

You can now import batches of ERwin files in a single operation using a new wizard.

Documented in:

- *Data Modeling > Building Data Models > Migrating from ERwin to PowerDesigner*

### *Generate PDMs from XSMs*

You can now generate a PDM database structure from an XML schema.

Documented in:

- *XML Modeling > Generating and Reverse Engineering XML Schemas and Other Models > Generating Other Models from an XSM*

### *New or Enhanced DBMS Support*

The following DBMS versions are added or enhanced:

- Sybase IQ v15.2



- Sybase ASE v15.5

Documented in:

- *Data Modeling > DBMS Definition Reference*

## **New Data Movement Model Features v15.2**

---

PowerDesigner v15.2 includes new features for the Data Movement Model (DMM).

### *Replication Server v15.2/15.5 Enhancements*

PowerDesigner provides new support for:

- Simplified connections to non-ASE replicate databases through connection profiles and connectors
- [v15.5 and higher] High Volume Adaptive Replication (HVAR)
- [v15.5 and higher] Generation of `alter replication definition` scripts
- Replication of SQL Statements (SQLMDL)

Documented in:

- *Data Movement Modeling > Working with Replication Server*

## **New Repository Features v15.2**

---

PowerDesigner v15.2 includes new features for the Repository.

### *Extensions Visible in Repository Browser and PowerDesigner Portal*

Extended objects and their properties now have the same status and visibility as standard objects in the repository Browser and PowerDesigner Portal.

### *Reuse Saved Searches in the PowerDesigner Portal*

You can now save search queries created in the PowerDesigner Portal interface for reuse.

Documented in:

- *Core Features Guide > Storing, Sharing and Reporting on Models > The PowerDesigner Portal > PowerDesigner Portal Search*



# New Features v15.1

The following sections describe the new features available in PowerDesigner v15.1.

## New Core Features v15.1

---

PowerDesigner v15.1 includes new core features available for all models.

### *New Model Dialog*

The **New Model** dialog has been completely redesigned to provide greater visibility to the diagrams that are available in each type of model. The new dialog is customizable so that you can:

- Organize the choice of models however you want
- Hide certain kinds of models from certain kinds of users
- Restrict or predefine the choice of target language using a new kind of model template

Documented in:

- *Core Features Guide > Modeling with PowerDesigner > Getting Started with PowerDesigner > Creating a Model*
- *Core Features Guide > Modeling with PowerDesigner > Getting Started with PowerDesigner > Creating a Model > Model Templates*

### *Welcome Page*

The new **Welcome** page gives you one-click access to all your recent projects, workspaces, and models, as well as providing a direct link to the New Model and New Project dialogs and a range of help materials.

Documented in:

- *Core Features Guide > Modeling with PowerDesigner > Getting Started with PowerDesigner > The Welcome Page*

### *Metamodel Extension Wizards*

You can now quickly add extensions to your PowerDesigner models with wizards available directly from object property sheets. You can specify new attributes and lists of associated objects and the changes to the underlying PowerDesigner metamodel are automatically saved in an extension file, which can be deployed to other users and edited in the Resource Editor.

Documented in:

- *Core Features Guide > Modeling with PowerDesigner > Objects > Extending Objects > Adding New Properties to an Object*

### *Dependency Matrix*

Dependency matrices, which allow you to analyze the dependencies between different kinds of objects, now display the hierarchy of parent objects. You can now display dependencies between types of objects that are not directly related by constructing complex paths traversing the PowerDesigner metamodel using the new Dependency Path Definition dialog.

Documented in:

- *Core Features Guide > Modeling with PowerDesigner > Diagrams, Matrices, and Symbols > Dependency Matrices*

### *More Diagrams with Customizable Display Preferences*

Extended objects, packages, and all the objects in the following kinds of diagrams now have completely customizable display preferences, which allow you to display any of their attributes and collections in any order that you want on their diagram symbols:

- Enterprise Architecture Model - All diagrams
- Business Process Model - All diagrams
- Data models:
  - Physical Data Diagram
  - Multidimensional Data Diagram
- Object-Oriented Model:
  - Use Case Diagram
  - Activity Diagram
  - Statechart Diagram
  - Interaction Overview Diagram
  - Deployment Diagram

Documented in:

- *Core Features Guide > Modeling with PowerDesigner > Diagrams, Matrices, and Symbols > Display Preferences*

### *Improved Property Filtering*

The **Customize Columns and Filter** dialog now includes a new Operator column with a list of common operators to simplify writing filter expressions.

Documented in:

- *Core Features Guide > Modeling with PowerDesigner > Objects > Object Lists > Customizing Object List Columns and Filtering Lists*

### *Improved RTF Support*

The PowerDesigner RTF editor provides improved support for tables and bulleted lists and the preservation of Word formatting. It now allows the insertion of pictures anywhere RTF input is supported.

*Other New Core Features*

- *Metamodel Help More Accessible* - You can now access the documentation of the PowerDesigner metamodel directly from an object's property sheet.
- *Right-Clicking a Group of Symbols* - When you select a group of symbols and right-click any of them, you can now modify all of them in any way that is appropriate.
- *Plugin Support* - The PowerDesigner plugin for Eclipse now supports Eclipse v3.4.

## **New Project and Framework Features v15.1**

PowerDesigner v15.1 includes new features for projects and frameworks.

*Framework Diagram*

The new framework diagram provides support for modeling frameworks that are not based on a matrix format. You can create framework nodes and draw connections between them in any format required. Individual nodes can be decomposed into sub-framework diagrams. Framework diagram nodes support all the same kinds of actions as framework matrix cells.

Documented in:

- *Core Features Guide > Modeling with PowerDesigner > Projects and Frameworks*

*Save Order Between Folders and Models*

You can now reorder folders and models within a project by drag and drop.

## **New Enterprise Architecture Model Features v15.1**

PowerDesigner v15.1 includes new features for the Enterprise Architecture Model (EAM).

*New Object Properties*

Many objects in the EAM have additional properties to enable you to model them more fully.

Documented in:

- *Enterprise Architecture Modeling*

*Richer Diagrams*

Hardware and software servers, network nodes, workstations, mobile devices, and networks, previously only available in technology infrastructure diagrams are now also authorized in application architecture diagrams.

In city planning diagrams, business functions can now be decomposed and display sub-functions.

Documented in:

## New Features v15.1

- *Enterprise Architecture Modeling*

### *Improved Exchange of Objects with Other Models*

When importing or exporting objects from or to other PowerDesigner models, sub-objects are now automatically included.

Documented in:

- *Enterprise Architecture Modeling > Importing to and Generating and Exporting from an EAM > Exporting and Importing Objects to and from Other Models*

### *Improved Visio Import*

You can now import custom properties defined in Visio.

Documented in:

- *Enterprise Architecture Modeling > Importing to and Generating and Exporting from an EAM > Importing Visio Diagrams into PowerDesigner*

## **New Business Process Model Features v15.1**

---

PowerDesigner v15.1 includes new features for the Business Process Model (BPM).

### *Improvements to Business Process Diagram*

Business process diagrams can now contain multiple pools of swimlanes. Linking between pools is supported, and you can group swimlanes and specify custom names for these groups.

Documented in:

- *Business Process Modeling > Building BPMs > Business Process Diagrams*

### *Improved Visio Import*

You can now import custom properties defined in Visio.

Documented in:

- *Business Process Modeling > Building Process Models > Importing Visio Diagrams into PowerDesigner*

## **New Data Model Features v15.1**

---

PowerDesigner v15.1 includes new features for the Physical Data Model (PDM).

### *Sybase IQ - Information Lifecycle Management*

Sybase IQ 15.0 provides new data placement capabilities and supports hierarchical storage management with relocation of less critical data to cheaper storage. PowerDesigner provides a simple modeling structure to cost effectively manage "aging" of data inside the data center

from 1st tier high performance storage for frequently accessed data through 2nd tier near-line storage for data that is infrequently accessed to 3rd tier archive storage for data that must remain available for regulatory audits.

Documented in:

- *Data Modeling > DBMS Definition Reference > Sybase AS IQ*

### *DBMS Triggers*

DBMS triggers are now supported for Oracle and MS SQL Server. These triggers are not associated with any table or view, and fire on modifications to the database structure itself, such as the creation or dropping of a table, or events like startup, shutdown, login etc. DBMS triggers can use trigger templates and trigger template items, just like table and view triggers.

Documented in:

- *Data Modeling > Building Data Models > Triggers and Procedures > DBMS Triggers (PDM)*

### *New or Enhanced DBMS Support*

The following DBMS versions are added or enhanced:

- Teradata v12
- IBM DB2 UDB v9.5 Common Server
- Sybase IQ v15.0 and v15.1

Documented in:

- *Data Modeling > DBMS Definition Reference*

## **New Data Movement Model Features v15.1**

---

PowerDesigner v15.1 includes new features for the Data Movement Model (DMM).

### *Replication Server® v15.x*

PowerDesigner now supports modeling for Replication Server® v15.x, and new usability enhancements make it easier to select maintenance users from attached PDMs. Data mapping for heterogeneous replication environments is now supported to allow the transparent remapping of datatypes for Oracle and other non-Sybase primary databases.

Documented in:

- *Data Movement Modeling > Working with Replication Server*

## **New Object-Oriented Model Features v15.1**

---

PowerDesigner v15.1 includes new features for the Object-Oriented Model (OOM).

### *XMI - Improved Support*

PowerDesigner now supports the import and export of UML models in the format XMI v2.1.

Documented in:

- *Object-Oriented Modeling > Building OOMs > Importing and Exporting an OOM in XMI Format*

### *Improvements to Activity Diagram*

Activity diagrams now support the creation of multiple starts and multiple pools of swimlanes. Linking between pools is supported, and you can group swimlanes and specify custom names for these groups. In addition you can now decompose activities directly in the parent diagram using the editable composite view mode.

Documented in:

- *Object-Oriented Modeling > Building OOMs > Dynamic Diagrams*

### *Improvements to Statechart Diagram*

The Statechart diagram now supports forks and joins, and states can be decomposed directly in the parent diagram using the editable composite view mode.

Documented in:

- *Object-Oriented Modeling > Building OOMs > Dynamic Diagrams*

## **New Repository Features v15.1**

---

PowerDesigner v15.1 includes new features for the Repository.

### *LDAP*

You can now configure repository access to be controlled by an LDAP server, so that it is no longer necessary to create separate repository accounts.

Documented in:

- *Core Features Guide > Administering PowerDesigner > Controlling Repository Access > Connecting to an LDAP Server for User Authentication*

### *Resource Sharing*

You can now store and deploy PowerDesigner resource files (target DBMSs, OO languages, etc) via the repository. A new auto-update option means that your team will always have the



latest version of your modeling target with all your extensions. You can combine your shared resource files with the new Model Category Sets to enforce their use for model creation.

Documented in:

- *Core Features Guide > Modeling with PowerDesigner > Customizing Your Modeling Environment > PowerDesigner Resource Files > Sharing and Embedding Resource Files*

#### *Hyperlinks in Stored Diagrams in PowerDesigner Portal*

Now you can click on any object symbol in a diagram viewed in the PowerDesigner Portal, and go directly to the object's property sheet.

